

H+SN

High Speed DC Circuit Breaker



Controlled Power, LLC

Controlled Power HSN High Speed DC Circuit Breakers

Each CP Type HSN circuit breaker unit can consist of either a wheeled truck and housing or be panel mounted. The circuit breaker can be mounted on the truck together with its mechanism, controls, closing, and tripping devices. The housing contains bus bars, cable connections, isolating contacts together with control relays and metering equipment. It is normal for a number of circuit breaker units to be side-by-side to form a switchboard. Housings which make up a switchboard are bolted together, while trucks remain independent, and can be readily inserted or withdrawn without disrupting the others. All trucks of a similar current rating are fully interchangeable.

Control switches and indicator lamps for each circuit breaker are mounted on the front panel of the truck. The control selector switch selects either local or remote control. The trip and close switch trips the breaker direct and either closes the breaker direct or initiates the load measuring auto-reclose sequence. The closing operation is powered by the closing solenoid which also charges the opening springs. The breaker can be closed by hand using the manual closing handle provided when UV is not supplied, but this is intended for emergency and maintenance operations only.

Step-down type housing designs are typically used in applications where the front panel must contain all metering and applicable instrumentation, or where minimal housing depth is important (such as inside traction power substations).

Typical HSN Breaker Elements

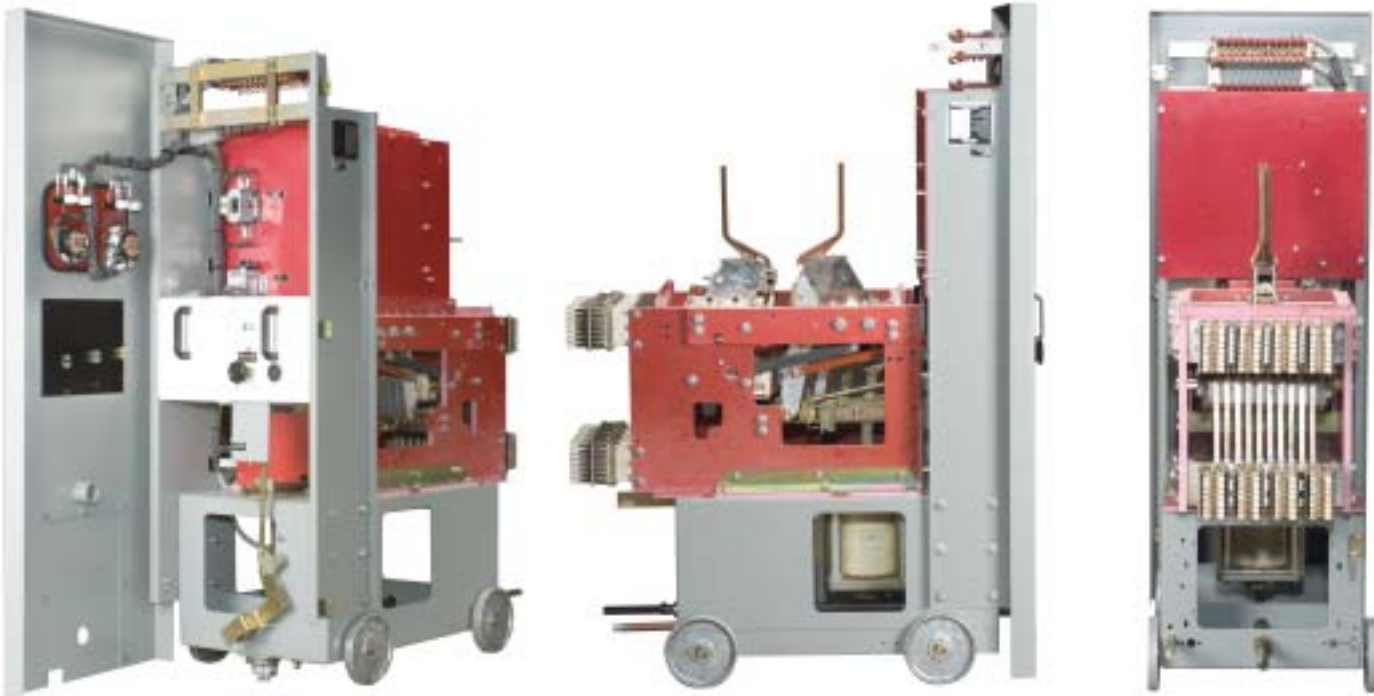
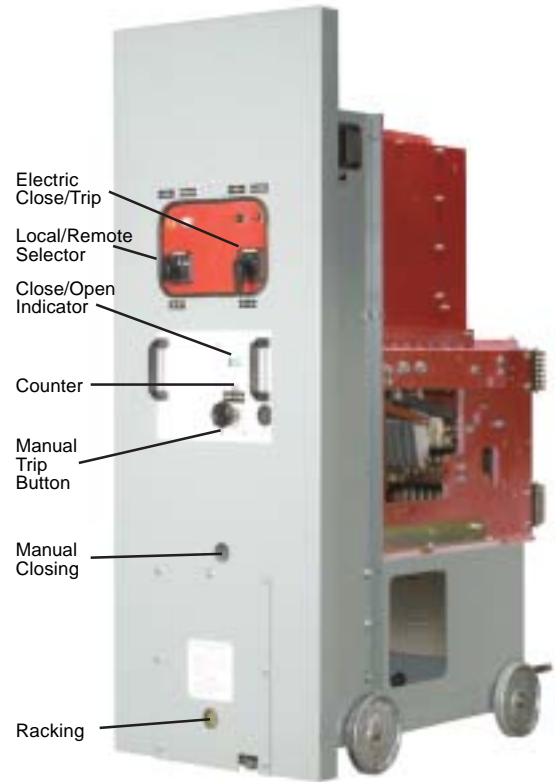

HSN High Speed Circuit Breaker.

HSN Circuit Breaker Ratings and Performance:

The HSN Type circuit breakers manufactured by CP have been tested in both open and closed type housings and free standing, in accordance with ANSI, BS and IEC specifications:

ANSI C37-14:1979 BS 4752:1977 IEC 157:1976
 ANSI C37-16:1980 BS 5227:1975 IEC 298:1981
 ANSI C37-17:1972
 ANSI C37-20:1974

Short Circuit Rating and Performance to BS/IEC Requirements:
 800V - 120kA sustained with 0.015 second time constant
 1600V - 60kA sustained with 0.015 second time constant

Short Circuit Rating and Performance to ANSI Requirements.

HSN switchgear is designed to meet the full requirements of ANSI specifications C37-16:1980 and C37-14:1979. Figure 1 below illustrates these requirements at 800 volts and also the compliance of the HSN switchgear which exceeds the requirements of all known applications. Typical ANSI C37-16 test "A" results are shown in Figure 2.

Figure 1

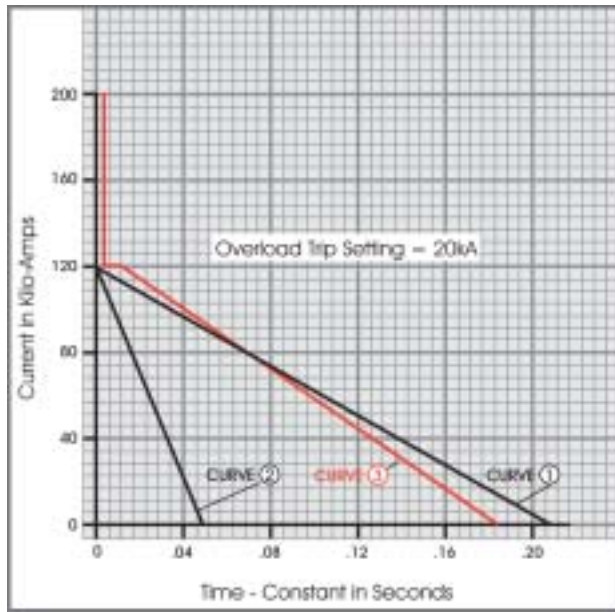
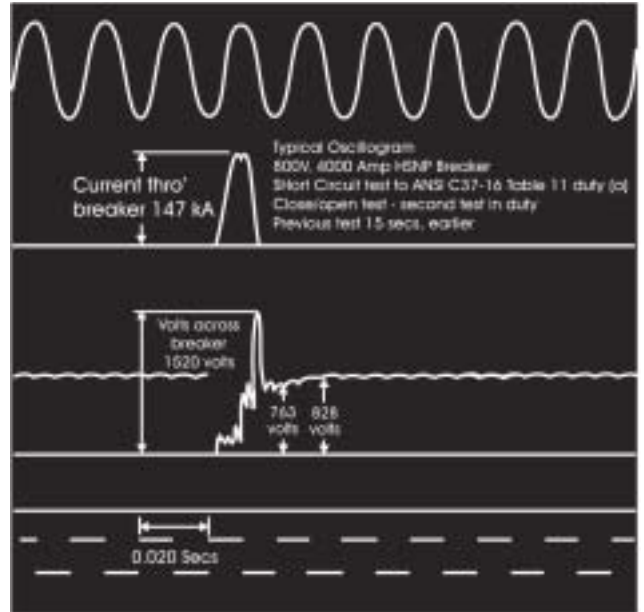

Figure 2



- Curve 1 = Requirements to table 11
- Curve 2 = Requirements to table 11A
- Curve 3 = HSN type tests

Type Tests carried out at 1600 volts exceeds the requirements of ANSI C37-16:1980 table 11A. As applications having longer time constants develop, proving tests are being performed using the special equipment necessary.

Figure 3 - Performance Ratings Table based on 800/1600 Volt

Frame Size (kA)	4				6				8				10				12			
Rated Continuous Current (kA)	4				6				8				10				12			
Rated Maximum Voltage (V)	800	1000	1200	1600	800	1000	1200	1600	800	1000	1200	---	800	---	---	---	800	---	---	---
Rated Peak Current (kA)	200	158	132	100	200	158	132	100	200	158	132	---	200	---	---	---	200	---	---	---
Rated Short-Time Current (kA)	120	96	80	60	120	96	80	60	120	96	80	---	120	---	---	---	120	---	---	---
Rated Short-Circuit Current (kA)	200	158	132	100	200	158	132	100	200	158	132	---	200	---	---	---	200	---	---	---
Overload Current Settings (kA)	4-16				6-24				8-32				10-40				12-48			
Rated Control Voltage	125vac (std), 48vac, or 120vac				125vac (std), 48vac, or 120vac				125vac (std), 48vac, or 120vac				125vac (std), 48vac, or 120vac				125vac (std), 48vac, or 120vac			

Maximum Safety:

Interlocks - In order to protect both equipment and operator from the dangers of operational error, as defined in ANSI Standards, each unit and breaker is provided with a system of mechanical interlocks which prevents:

- 1) The circuit breaker from being moved from connected, test or disconnected positions unless the main contacts are open and prevented from closing.
- 2) The breaker being closed unless it is in connected, test or disconnected positions, or when fully withdrawn.
- 3) The breaker causing damage to shutters (a stop restricts the travel of the truck within it's unit).

An optional interlock is also available to prevent a breaker of incorrect rating or function being engaged in a unit. Padlocking points can also be provided to prevent unauthorized operation.



Typical HSN Circuit Diagram:

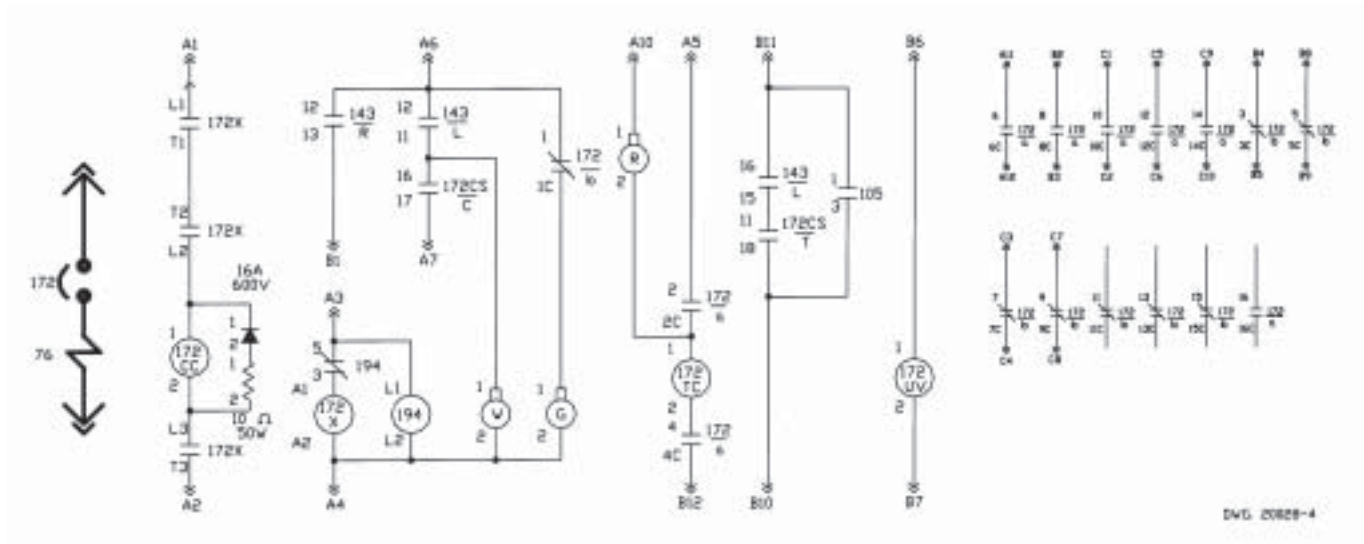

HSN Circuit Breaker Dimensions: Dimensions shown in Inches

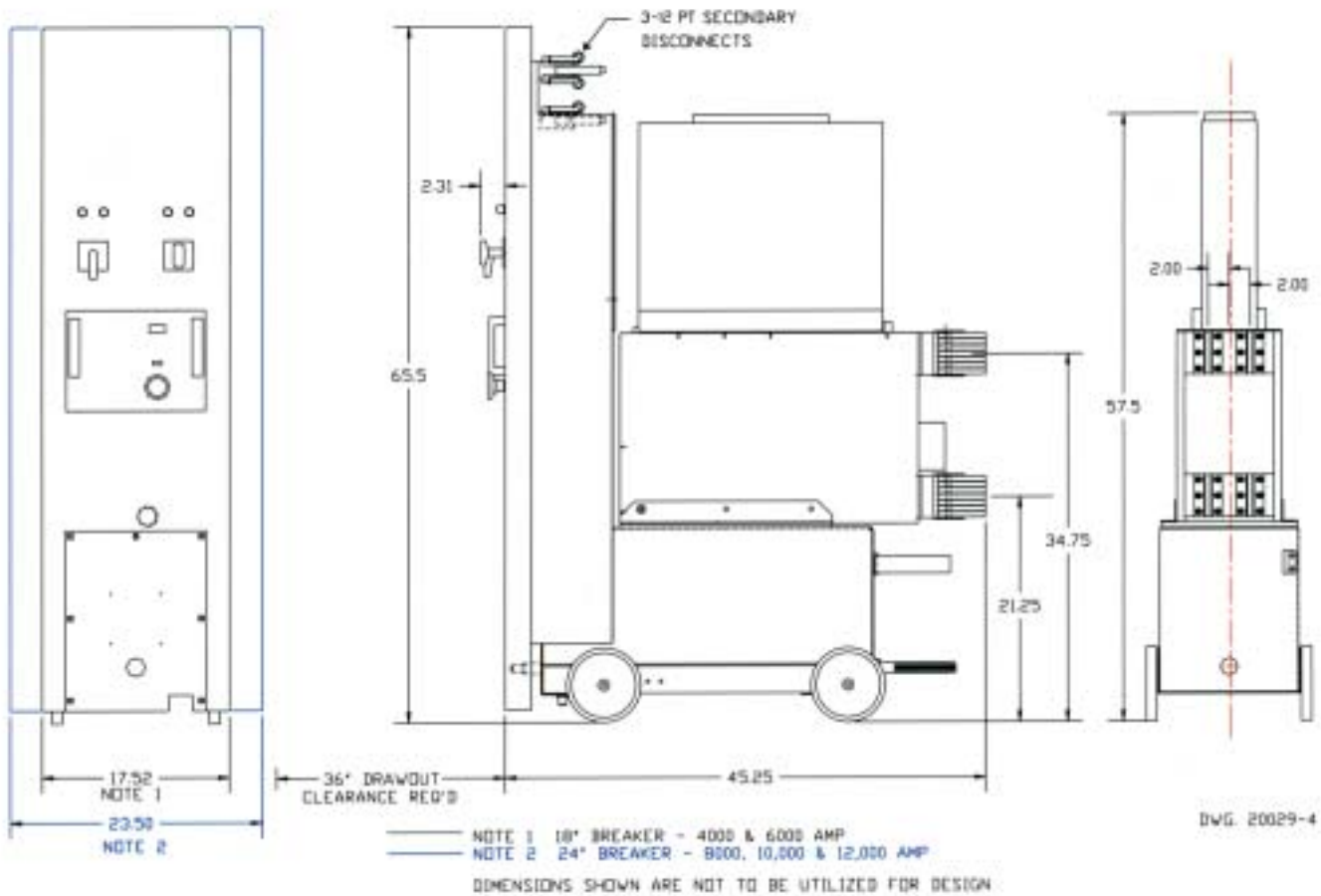

Note: 4000A & 6000A breakers can be furnished for use in 24" wide cells.

HSN High Speed Stationary Mounted Circuit Breaker:

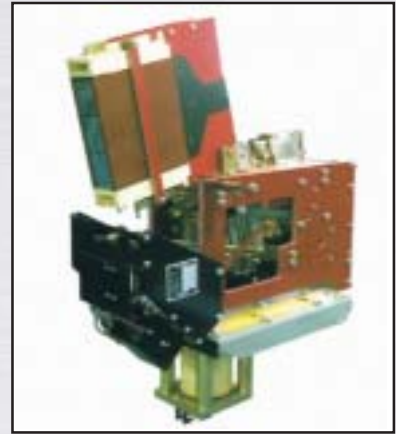

HSN High Speed Circuit Breaker Options:

- Stationary Mounted or Drawout
- Kirk Key Interlock Provision
- 125 VDC, 120 VAC Control Voltage
- Instantaneous Under Voltage Device
- Hinged Arc Chute (Stationary Only)
- High Speed Impulse Trip
- Series Trip Indication
- Local Control Switch
- Double Shunt Trip Coils
- Remote/Local Selector

HSN Circuit Breaker Net Weights (LBS):

Circuit Breaker Rating	Stationary Mounted Breaker	Draw-out Breaker
4000	496	840
6000	520	864
8000	556	1010
10000	588	1040
12000	620	1075

Controlled Power HSN Retrofitting

Controlled Power can retrofit your existing Bertram Thomas and GEC breakers with our HSN Breaker and extend the life of your equipment. We can convert from blow-out coil technology to cold cathode technology. Circuit breakers manufactured prior to 1980 contain some asbestos material. Controlled Power offers asbestos abatement as required. Call us today for more information.



Phone: 330.834.3200 • Fax: 330.834.3201

www.controlledpower.com